

# TR6530

ITEM NO.	MATERIAL
1	24oz 090 fiberglass
2	2 lb/cu <sup>3</sup> urethane foam
3	150g trevira

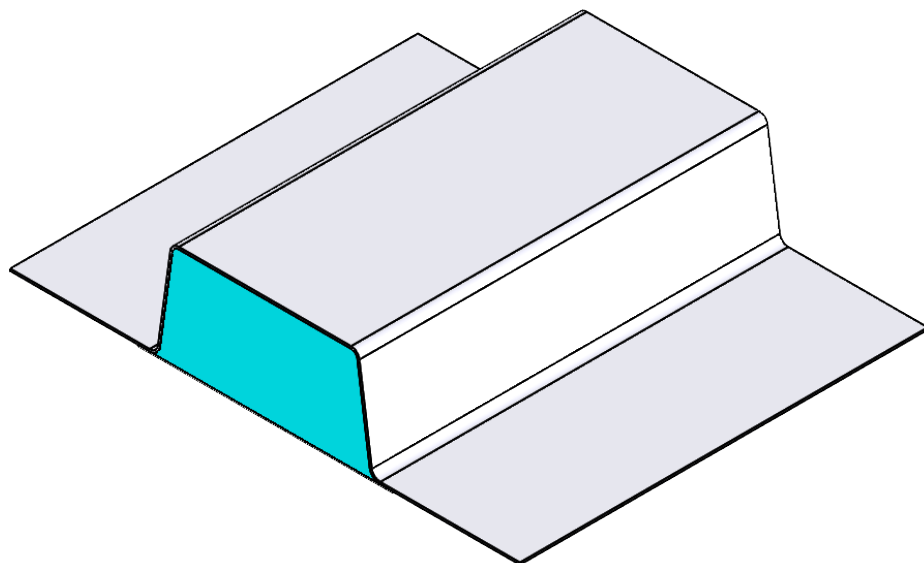
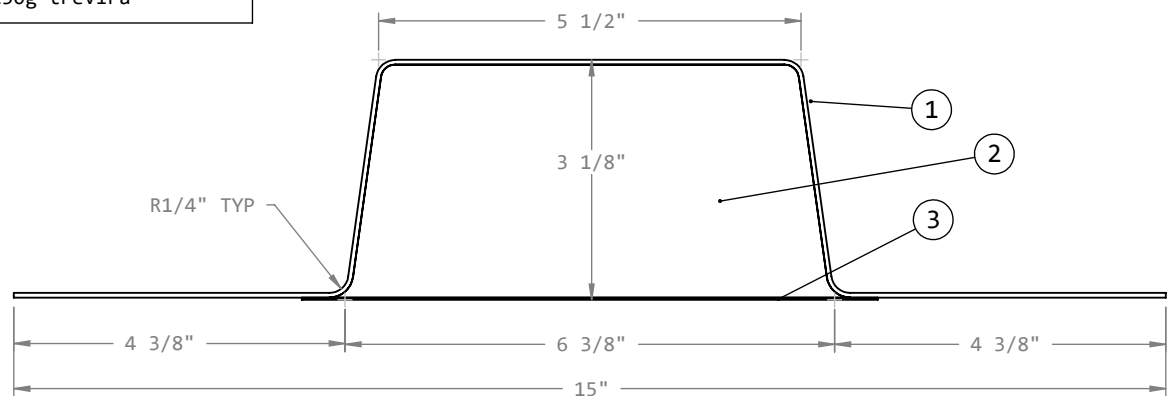

## CONTACT US

For questions  
Michael Canfield  
Ph. 321.917.2299  
E. mcanfield@preforms.com

For orders  
Tanya McCaully  
Ph. 321.255.0399 ext.100  
E. customerservice@preforms.com

## NOTES

1. Tolerances: ± 1/4"