

TR2515

ITEM NO.	MATERIAL
1	24oz 090 fiberglass
2	2 lb/cu ³ urethane foam
3	150g trevira

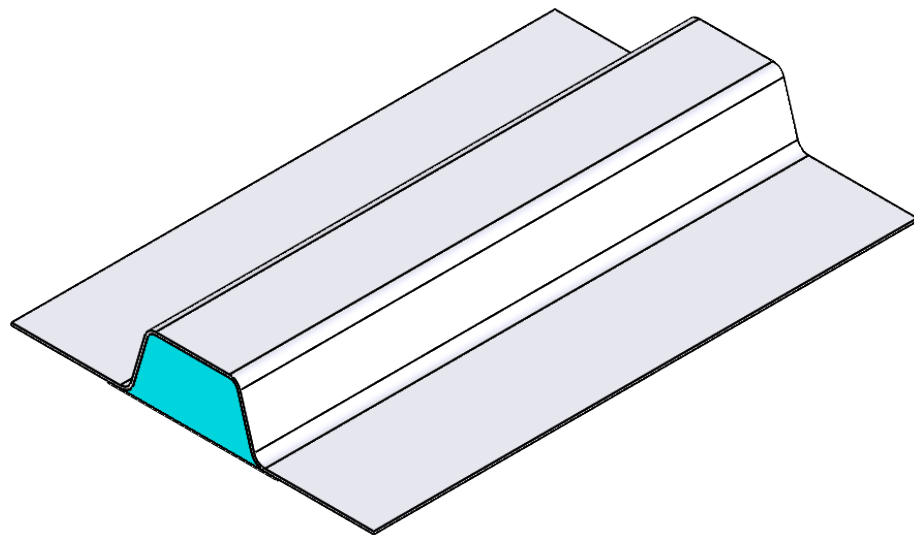
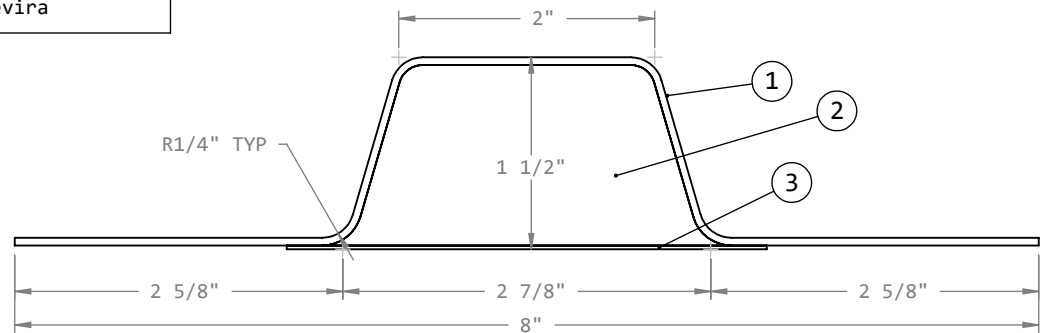

CONTACT US

For questions
Michael Canfield
Ph. 321.917.2299
E. mcanfield@preforms.com

For orders
Tanya McCaully
Ph. 321.255.0399 ext.100
E. customerservice@preforms.com

NOTES

1. Tolerances: ± 1/4"